

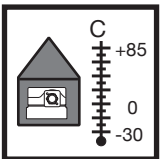

Betriebs- und Montageanleitung

**Klima-Set
KS...A2-7**

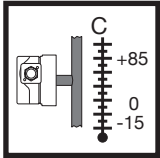
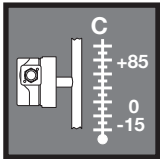
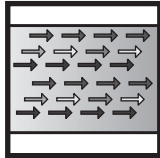
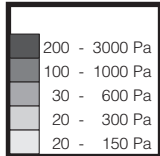
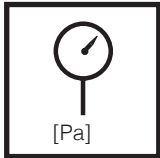
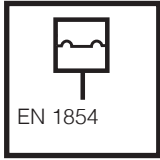

Operation and assembly instructions

**Klima-Set
KS...A2-7**

**Druckwächter/ Pressure Switch/
Pressostat/ Pressostato**
nach / acc. / selon / a norme
DIN EN 1854

Konform mit 2011/65/EU
Conform to 2011/65/EC
Conforme à la directive 2011/65/CE
Conforme della direttiva 2011/65/CE

Max. Betriebsdruck / Max. operating
pressure / Pression de service maxi.
Max. pressione di esercizio
KS...A2-7
p_{max.} = 10 kPa (100 mbar)

**Einstellbereiche
Setting ranges
Plages de réglage
Campi di taratura**

Luft- und Rauchgase
Air and flue gases
Air, fumée et gaz brûlés
Gas di combustione e aria

Umgebungstemperatur
Ambient temperature
Température ambiante
Temperatura ambiente
KS...A2-7 -15 °C ... +85 °C

Mediumtemperatur
Medium temperature
Température du fluide
Temperatura fluido
KS...A2-7 -15 °C ... +85 °C

Lagertemperatur
Storage temperature
Température de stockage
Temperatura stoccaggio
KS...A2-7 -30 °C ... +85 °C

Notice d'emploi et de montage

**Klima-Set
KS...A2-7**

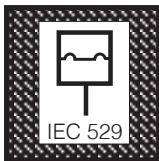
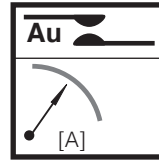

Istruzioni di esercizio e di montaggio

**Klima-Set
KS...A2-7**

**DDC-Anwendung/DDC applica-
tion/application DDC/Applica-
zione DDC**
=(DC) min./mini. 5 V,
=(DC) max./maxi. 24 V



**Standard Anwendung/Standard
application/Application standard
Application standard**
~(AC) eff., min./mini 24 V,
~(AC) max./maxi. 250 V,
=(DC) min./mini. 24 V,
=(DC) max./maxi. 48 V

**DDC-Anwendung/DDC applica-
tion/application DDC/Applica-
zione DDC**
**Nennstrom/nominal current/cou-
rant nominal/corrente nominale**
=(DC) 20 mA
**Schaltstrom/current on contact/
courant de commutation/cor-
rente di intervento**
=(DC) min./mini. 5 mA
=(DC) max./maxi. 20 mA

**Standard Anwendung/Standard
application/Application standard
Application standard**
**Nennstrom/nominal current/cou-
rant nominal/corrente nominale**
~(AC) 6 A
**Schaltstrom/current on contact/
courant de commutation/cor-
rente di intervento**
~(AC) eff., min./mini 20 mA,
~(AC) max./maxi. 4 A cos φ 1
~(AC) max./maxi. 2 A cos φ 0,6
=(DC) min./mini. 20 mA
=(DC) max./maxi. 1 A

Schutzart / Degree of protection
Protection / Protezione
IP 54 nach / acc. / selon / a norme
IEC 529 (EN 60529)
Optional / Optional
en option / Optional **IP 65**

Betriebsanleitung
bitte lesen und aufbewahren.
Arbeiten dürfen nur von Fachper-
sonal durchgeführt werden.
Operation manual
Please read the operation manual
and keep it at a safe place.
Only skilled personnel is allowed
to carry out work.
This unit must be installed in ac-
cordance with current regulations
Veuillez lire et conserver le mode
d'emploi.
Les travaux doivent être effectués
uniquement par des professi-
onnels qualifiés.
Leggere e conservare le istruzioni
di esercizio.
I lavori devono essere eseguiti
esclusivamente da personale

Typ Type Tipo	Bestell-Nummer mit Zubehör Ordering No. with accessories Code article N° avec access. Nr. Codice con accessori (1 x)	Meßbereich einstellbar Setting range adjustable Plage de réglage à pression Campo taratura pressione	Einstellbereich Setting range Plages de réglage Campi di taratura min. / max.	Justage Adjustment Regolazione	Schaltdifferenz Switching differ- ential Différentiel Differenza com- mutazione Δp [Pa]	Einbaulage Schaltpunktänderung Installation position switching point Position de montage point d'enclenchement Posizione di montaggio mo- difica punto di accensione max. [Pa] 
KS 150 A2-7	257 842	20 - 150 Pa	± 8 Pa / ± 15 %		≤ 18	± 0 +50 -50
KS 300 A2-7	257 843	20 - 300 Pa	± 8 Pa / ± 15 %		≤ 20	± 0 +50 -50
KS 600 A2-7	257 844	30 - 600 Pa	± 10 Pa / ± 15 %		≤ 30	± 0 +50 -50
KS 1000 A2-7	257 845	0,1 - 1,0 kPa	± 15 %		≤ 40	± 0 +50 -50
KS 3000 A2-7	257 846	0,3 - 3,0 kPa	± 15 %		≤ 80	± 0 +50 -50

Lieferumfang Klima-Set

- Differenzdruckwächter
KS... A2-7
- Befestigungsplatte
- Anschlußschlauch
ø 4 x 1,5 x 2000
- 6 x Befestigungsschrauben
- 2 x Schlauchanschlüsse
- 2 x Verlängerungsrohre
- Betriebs- und Montageanleitung
www.dungs.com

Klima-Set - kit contains

- Differential pressure switch
KS... A2-7
- Mounting plate
- Connection tube
dia. 4 x 1,5 x 2000
- 6 x Mounting screws
- 2 Hose connections
- 2 Synthetic tubes
- Operation and assembly
instructions
www.dungs.com

Klima-Set - le kit comprend

- Pressostat différentiel
KS... A2-7
- Plaque de fixation
- Flexible ø 4 x 1,5 x 2000
- 6 x Vis de fixation
- 2 Brides de raccordement
- 2 Tubes de prise d'air
- Notice d'emploi et de montage
www.dungs.com

Kit di fornitura Klima-Set

- Pressostato differenziale
KS... A2-7
- Piastra di fissaggio
- Cavo flessibile per collegamen-
to ø 4 x 1,5 x 2000
- 6 x Vite di fissaggio
- 2 Attacchi cavo flessibile
- 2 Prolunghe
- Istruzioni di esercizio e mon-
taggio
www.dungs.com

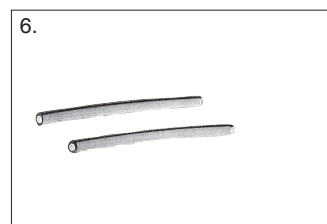
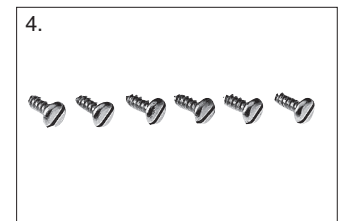
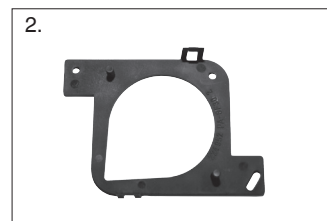
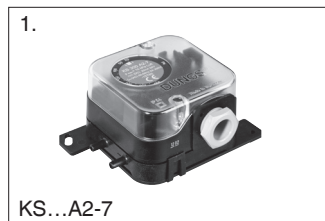

Montage-Set Glimmlampen
Neon glow lamp assembly set
Lampes fluorescentes, kit de
montage
Set die montaggio lampadina a
bagliore
grün/green/verte/verde

230 V	24 V
248 239	248 240

Montage-Set Glimmlampen
Neon glow lamp assembly set
Lampes fluorescentes, kit de
montage
Set die montaggio lampadina a
bagliore
gelb/yellow/jaune/giallo

230 V	120 V	24 V
231 773	231 772	231 774

Ersatz-Set Haube IP 65
Replacement set cover IP 65
Kit de replacement capot IP 65
Set di ricambio calotta IP 65
KS...A2-7 257 841

Ersatzdruckwächter ohne Zubehör
Spare pressure switch without
accessories
Pressostat de remplacement sans
accessoires
Pressostato di ricambio senza
accessori

KS 150 A2-7	260 427
KS 300 A2-7	260 428
KS 600 A2-7	260 429
KS 1000 A2-7	260 430
KS 3000 A2-7	260 431

Adapter
Adapter
Adaptateur
Adattatore
ø 4/6 (2 x) 266 037

Ersatzteile / Zubehör Spare parts / Accessories Pièces de rechange / access. Parti di ricambio / Accessori	Bestell-Nummer Ordering No. No. de commande Codice articolo
Set: Gerätestecker G3, 3-polig ohne Erde Set: appliance connector G3, 3-pin without earthing Kit : Fiche d'appareil G3, 3 pôles sans terre Set spina G3 a 3 poli senza terra	231 770
Befestigungsplatte Mounting plate Plaque de fixation Piastra di fissaggio	230 301
Klima-Set Zubehör KS...A2-7 Climatic set accessories KS...A2-7 Clima-set access. KS...A2-7 Klima-Set accessori KS...A2-7	258 247
Leitungsdose, grau Line socket, grey Prise, noire Spina grigia, nera GDMW, 3 pol. + E	210 318

Einbaumaße / Dimensions
Cotes d'encombrement / Dimensioni [mm]
KS...A2-7

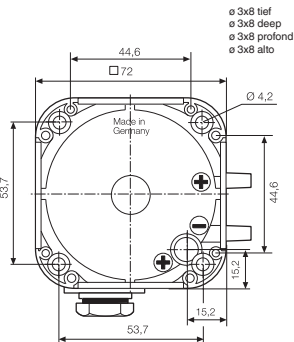
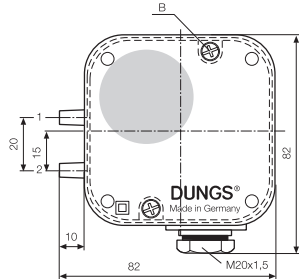
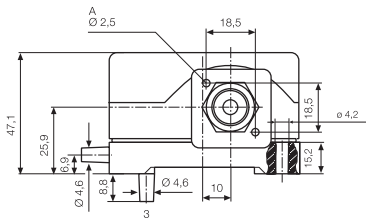

ø 3x8 tief
 ø 3x8 deep
 ø 3x8 profond
 ø 3x8 alto

Einbaumaße / Dimensions
Cotes d'encombrement / Dimensioni [mm]
Befestigungsplatte / Befestigungsplatte
Befestigungsplatte / Befestigungsplatte

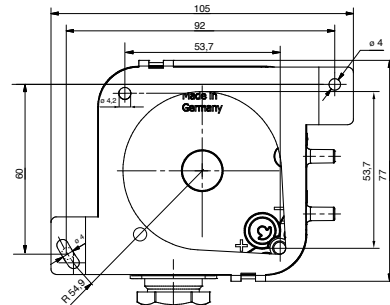

- A** Ø 2,5 für Gerätestecker
 DIN EN 175 301-803
- B** Längsschlitz 0,8 und
 Kreuzschlitz
 DIN EN ISO 4757-Z2
- 1** Druckanschluß (+)
 Anschluß des höheren
 Druckes
- 2** Druckanschluß (-)
 Anschluß des niedrigeren
 Druckes
- 3** optional
Druckanschluß (+)
 Anschluß des höheren
 Druckes

- A** 2.5 dia. for connector socket
 DIN EN 175 301-803
- B** Longitudinal slot 0.8 and
 cross-head
 DIN EN ISO 4757-Z2
- 1** Pressure connection (+)
 Connects higher pressure
- 2** Pressure connection (-)
 Connects lower pressure
- 3** optional
pressure connection (+)
 Connects higher pressure

- A** Ø 2,5 pour socle de connec-
 teur DIN EN 175 301-803
- B** Empreinte longitudinale 0,8
 et cruciforme
 DIN EN ISO 4757-Z2
- 1** Prise de pression (+)
 Raccordement de la pression
 plus élevée
- 2** Prise de pression (-)
 Raccordement de la pression
 plus basse
- 3** En option prise de pression
 (+)
 Raccordement de la pression
 plus élevée

- A** Ø 2,5 per spina apparecchio
 DIN EN 175 301-803
- B** Taglio longitudinale 0,8 e
 taglio a croce
 DIN EN ISO 4757-Z2
- 1** Attacco pressione (+)
 Collegamento della pres-
 sione più alta
- 2** Attacco pressione (-)
 Collegamento della pres-
 sione più bassa
- 3** A richiesta attacco pressio-
 ne (+)
 Collegamento della pres-
 sione più alta

Druckanschluß

Geeignete Schläuche (für Luft, Rauch- und Abgase) einsetzen.

Schläuche gegen unbeabsichtigtes Abziehen sichern: **Kabelbinder** oder **Schlauchschelle** oder Ω -Schelle.

A: max. ø 4 mm
B: max. ø 15 mm

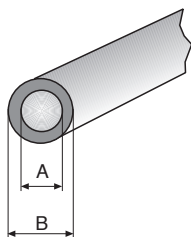

Pressure connection

Use suitable hoses (for air, flue and exhaust gases)

Secure hoses to prevent unintentional removal: use **cabl e tie** or **cabl e clip** or Ω clip.

Prise de pression

Utiliser les tubes appropriés (pour l'air, la fumée et les gaz brûlés).

Faire le nécessaire afin que les tubes ne puissent pas être enlevés par inadvertance: **fixation par attache - collier** ou **clips** Ω .

Attacco di pressione

Per aria, gas di combustione e di scarico, impiegare tubi flessibili adeguati

Assicurare i tubi contro il pericolo di distacco involontario servendosi di serratubi, **fascette per tubi** o **fascette a forma di Ω** .

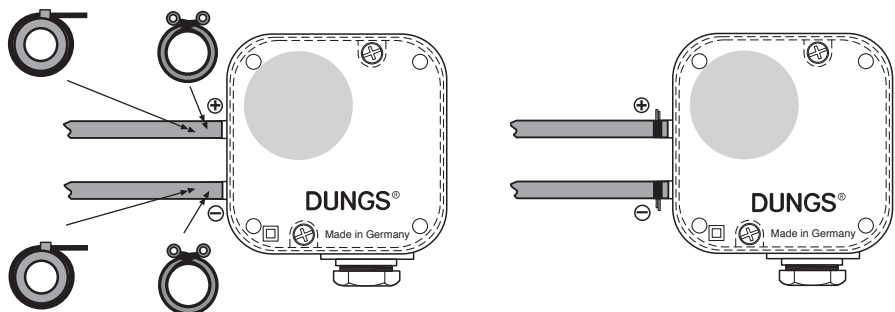

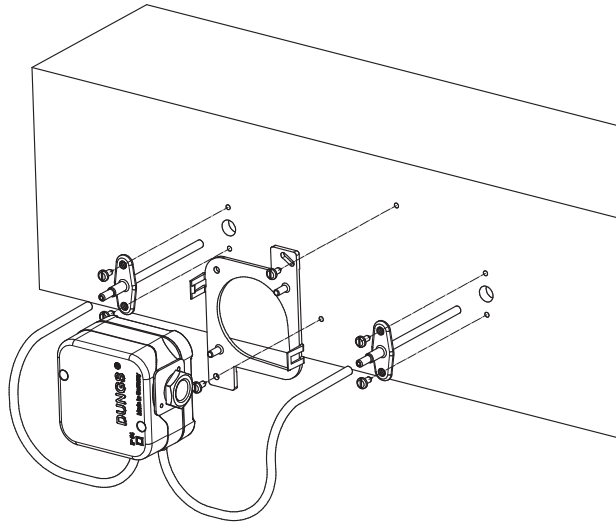

! Kondensat darf nicht in das Gerät gelangen. Bei Minustemperaturen, durch Vereisung Fehlfunktion/Ausfall möglich.

! Do not allow condensate to flow into the equipment. In case of sub-zero temperatures, malfunction or equipment failure may be possible due to icing.

! Eviter l'entrée de condensat dans le pressostat, une prise en glace par température négative nuirait à son fonctionnement.

! Nell' apparecchio non deve infiltrarsi alcuna condensa. Alle temperature negative sarebbero possibili disfunzioni dovute a formazione di ghiaccio.

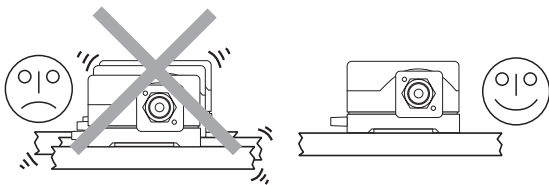

! Auf vibrationsfreien Einbau achten!

! Veiller à ce que l'appareil ne subisse pas de vibrations!

! Ensure that the pressure switch is installed free of vibration!

! Evitare possibilità di vibrazioni!

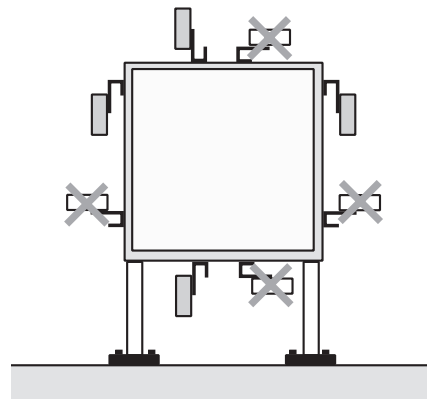

! Einbaulage: Vorzugsweise senkrecht, bitte beachten

! Position de montage: de préférence verticale.

! Installation position : please note, vertical position preferable

! Posizione di montaggio: tenere presente che è preferibile la posizione verticale.

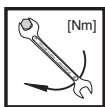

max. Drehmomente	M 4	G 1/8	G 1/4	ø 3x14
max. torque	<hr/>			<hr/>
max. couple	2,5 Nm	5 Nm	7 Nm	1,2 Nm
max. coppie				



Geeignetes Werkzeug einsetzen!
Please use proper tools!
Utiliser des outils adaptés!
Impiegare gli attrezzi adeguati!

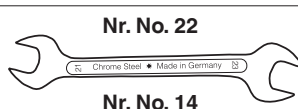

KS ... A2-7
 Unterdrucküberwachung
 Vacuum control
 Contrôle de vide
 Controllo depressione

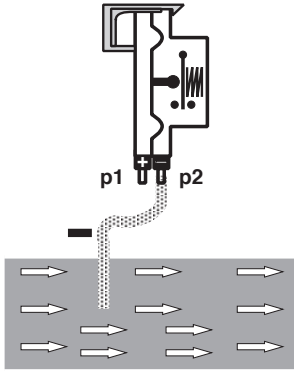

Das Klima-Set wird über Anschluß p2(-) mit dem Luftkanal verbunden. Der Anschluß p1(+) wird nicht mit dem Luftkanal verbunden, muß jedoch geöffnet bleiben.

Vorsicht: Durch den geöffneten Anschluß p1(+) darf kein Schmutz in das Gerät eindringen!

The Klima-Set is connected via connection p2(-) with the air duct. Connection p1(+) is not connected with the air duct but has to stay open. Attention: take care to prevent the ingress of dirt via connection p1(+)

Le Klima-Set est relié via le raccord p2(-) à la conduite d'air. Le raccord p1(+) n'est pas relié à la conduite, il communique avec la pression atmosphérique.

Attention: prendre toutes les précautions afin d'éviter un encrassement de l'appareil via le raccord p1(+)

Il Klima-Set é collegato con il canale aria attraverso l'attacco p2(-). L'attacco p1(+) non é collegato, ma tuttavia rimanere aperto.

Attenzione: con l'attacco p1(+) aperto fare attenzione che non entri polvere nell'apparecchio!

KS ... A2-7
 Filterüberwachung
 Filter control
 Contrôle de filtrage
 Controllo filtro

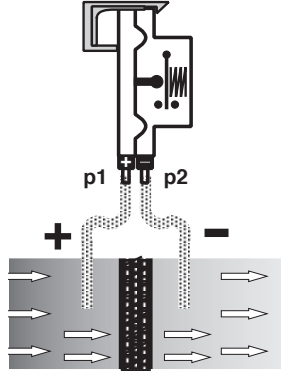

In Flußrichtung des Volumensstromes wird der Anschluß p1(+) vor und der Anschluß p2(-) nach dem Filter mit dem Luftkanal verbunden.

In direction of the volume flow connection p1(+) is connected before and connection p2(-) after the filter in the air duct.

Le raccord p1(+) est relié à la conduite d'air en amont du filtre. Le raccord p2(-) est relié à la conduite en aval du filtre.

Nelle direzione di flusso vengono collegati: l'attacco p1(+) prima, e l'attacco p2(-) dopo il filtro, al canale dell'aria.

KS ... A2-7
 Gebläseüberwachung
 Fan control
 Contrôle de ventilation
 Controllo ventilatore

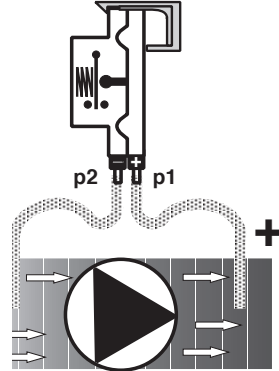

Bei der Gebläseüberwachung wird der Anschluß p1(+) druckseitig nach dem Gebläse und der Anschluß p2(-) vor dem Gebläse mit dem Luftkanal verbunden.

When controlling the fan, connection p1(+) is connected after the fan (in blowing direction) and connection p2(-) is connected in the air duct before the fan.

Le raccord p1(+) est relié à la conduite d'air en aval de la soufflerie. Le raccord p2(-) est relié à la conduite en amont de la soufflerie.

Nel controllo ventilatore vengono collegati al canale dell'aria: l'attacco p1(+) sul lato pressione dopo le soffiante, e l'attacco p2(-) prima della soffiante.

KS...A2-7
 Druckanschlüsse
 Pressure connections
 Raccordement pneumatique
 Prese pressione

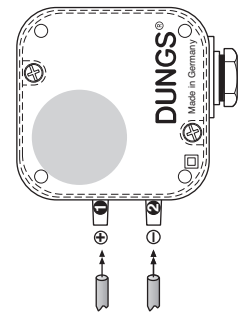

p1 (+) ø 4 mm
p2 (-) ø 4 mm
p3 (+) ø 4 mm
optional/optional/
en option/opzione

<p>Der Anschluß des höheren Überdruckes erfolgt immer am Anschluß p1(+). Der Anschluß des höheren Unterdruckes erfolgt immer am Anschluß p2(-).</p>	<p>Beispiel - Systemüberdruck höherer Überdruck: z.B. 240 Pa: Anschluß p1(+) niederer Überdruck: z.B. 180 Pa: Anschluß p2(-)</p>	<p>Beispiel - Systemunterdruck niederer Unterdruck: z.B. -130 Pa: Anschluß p1(+) höherer Unterdruck: z.B. -210 Pa: Anschluß p2(-)</p>
<p>The connection of the higher over pressure should always be made to connection p1(+). The higher vacuum should always be connected to connection p2(-).</p>	<p>Example - Positive pressure in system: Higher overpressure: f.ex. 240 Pa: Connection p1(+) Lower overpressure: f.ex. 180 Pa: Connection p2(-)</p>	<p>Example - Negative pressure in system: Lower vacuum: f.ex. -130 Pa: Connection p1(+) Higher vacuum: f.ex. -210 Pa: Connection p2(-)</p>
<p>La pression supérieure dans un système pressurisé est toujours reliée au raccord p1(+). La pression supérieure dans un système dépressurisé est toujours reliée au raccord p2(-).</p>	<p>Exemple - système pressurisé: pression supérieure: par exp. 240 Pa: raccord p1(+) pression inférieure: par exp. 180 Pa: raccord p2(-)</p>	<p>Exemple - système dépressurisé: pression inférieure: par exp. -130 Pa: raccord p1(+) pression supérieure: par exp. -210 Pa: raccord p2(-)</p>
<p>L'attacco di sovrappressione maggiore si effettua sempre all'attacco p1(+). L'attacco della depressione maggiore sempre all'attacco p2 (-).</p>	<p>Esempio di sovrappressione maggiore: 240 Pa: attacco p1(+) Esempio di sovrappressione minore: 180 Pa: attacco p2(-)</p>	<p>Esempio di depressione minore: -130 Pa: attacco p1(+) Esempio di depressione maggiore -210 Pa: attacco p2(-)</p>

DDC - Anwendung
KS...A2-7

Die Schaltkontakte des Klima-Sets sind aus Silber galvanisch vergoldet, für =(DC) 24V; 0,02 A. Beim Einsatz des Klima-Sets in der konventionellen Technik ~ (AC) 250V, (ohmsche Last 4A) induktive Last 2 A bei $\cos \varphi 0,6$ brennt der vergoldete Überzug an den Schaltkontakten ab.

DDC Application
KS...A2-7

The switching contacts of the Klima-Set are made of silver with gold plating =(DC) 24V; 0,02 A. When the Klima-Set is used conventionally e.g. ~ (AC) 250 V, (ohmic 4 A) inductive 2 A at $\cos \varphi 0,6$, the gold coating on the contacts will be destroyed.

Application en DDC
KS...A2-7

Grâce à ses contacts en argent dorés galvaniquement, le Klima-Set est parfaitement utilisable en tant que capteur dans les procédés industriels automatisés. Il fonctionne alors sous =(DC) 24 V, l'intensité de courant est de 0,02 A. Une utilisation conventionnelle du Klima-Set sous ~ (AC) 250V, (charge résistive 4 A) charge inductive 2 A, $\cos \varphi 0,6$, dégrade la dorure.

Impiego come controllo elettronico digitale
KS...A2-7

I contatti elettrici del Klima-Set sono in argento dorato galvanicamente per =(DC) 24 V; 0,02 A. Con l'impiego del Klima-Set nella tecnologia convenzionale p.es. ~ (AC) 250 V, (carico ohmico 4 A) carico induttivo 2 A, $\cos \varphi 0,6$, il rivestimento dorato si svernicia sui contatti.

Dadurch ist eine spätere DDC-Anwendung nicht mehr möglich.

Therefore a subsequent use in DDC-application will no longer be possible.

Ce qui interdit une utilisation ultérieure du Klima-Set en tant que capteur.

Di conseguenza non è più possibile il suo impiego come controllo elettronico digitale.

Schaltfunktionen
KS...A2-7

bei steigendem Differenzdruck:

- 1 NC öffnet
- 2 NO schließt

bei fallendem Differenzdruck:

- 1 NC schließt
- 2 NO öffnet

Switching functions
KS...A2-7

whilst differential pressure is increasing:

- 1 NC opens
- 2 NO closes

whilst differential pressure is decreasing:

- 1 NC closes
- 2 NO opens

Fonctions de commutation
KS...A2-7

pression différentielle croissante:

- 1 NC ouvre
- 2 NO ferme

pression différentielle décroissante:

- 1 NC ferme
- 2 NO ouvre

Funzioni di commutazione
KS...A2-7

con pressione differenziale in salita:

- 1 NC apre
- 2 NO chiude

con pressione differenziale in discesa:

- 1 NC chiude
- 2 NO apre

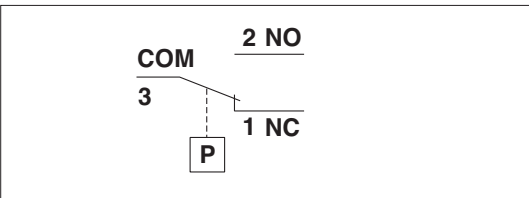

KS...A2-7
Elektrischer Anschluß

IEC 730-1 (DIN EN 60 730 T1)

Über Kabeleinführung M20x1,5, mit Zugentlastung, an Schraubenklemmen für Kabel $\varnothing 7$ bis $\varnothing 12,5$ mm.

 **Berührungsschutz ist nicht grundsätzlich gewährleistet, Kontakt mit spannungsführenden Teilen möglich!**

Zur Erhöhung der Schaltleistung wird bei DC-Anwendungen < 20 mA und DC 24 V der Einsatz eines RC-Gliedes empfohlen.

KS...A2-7
Electrical connection

IEC 730-1 (DIN EN 60 730 T1)

Via cable input M20x1,5, with rubber grommet suitable for cables between 7 and 12.5 mm diameter.

 **There is no protection against accidental contact. Contact with live parts is possible!**

To increase the switching capacity, we recommend that you use a RC device for current values < 20 mA and 24 V d.c. applications.

KS...A2-7
Raccordement électrique

IEC 730-1 (DIN EN 60 730 T1)

Raccordement sur bornier à vis par M20x1,5 pour câble de $\varnothing 7$ à $\varnothing 12,5$ mm.

 **La protection n'est pas garantie, contact avec des pièces sous tension possible!**

Pour augmenter la puissance de rupture, l'utilisation d'un circuit RC est préconisée pour les applications à courant continu < 20 mA et =(DC) 24 V.

KS...A2-7
Allacciamento elettrico

IEC 730-1 (DIN EN 60 730 T1)

Con passacavo M20x1,5, con scarico della trazione, collegato a morsetti a vite per cavi $\varnothing 7$ fino $\varnothing 12,5$ mm.

 **Non è sostanzialmente garantita la protezione da scariche, è possibile il contatto con conduttori di tensione.**

Per aumentare la potenza d'inserimento con applicazioni DC < 20 mA e 24 V, consigliamo l'impiego di un elemento RC.

optional
optional
en option
opzione
DIN EN 175 301-803

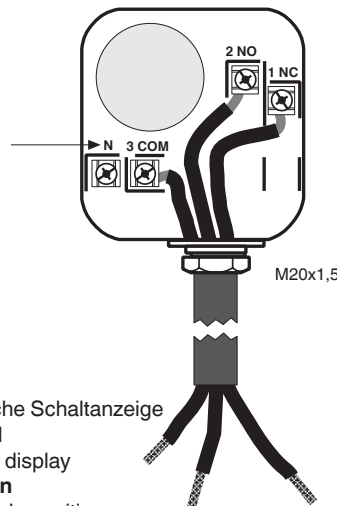
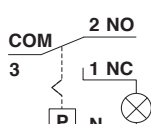
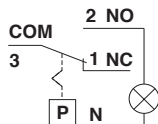
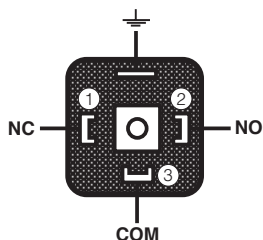

N optional
für optische Schaltanzeige
Optional
for visual display
en option
Contrôle de position
opzione
per visualizzazione di comando
ottica

Einstellung des Druckwächters

Haube mit geeignetem Werkzeug demontieren, Schraubendreher No. 3 bzw. PZ 2, Bild 1. Haube abnehmen.

! **Berührungsschutz ist nicht grundsätzlich gewährt, Kontakt mit spannungsführenden Teilen möglich.**

Einstellung KS...A2-7

Druckwächter am Einstellrad mit Skala **■** auf vorgeschriebenen Drucksollwert einstellen, Bild 2.

Anleitung des Brennerherstellers beachten!

Druckwächter schaltet bei steigendem Druck: Einstellung **↑**.
Druckwächter schaltet bei fallendem Druck: Einstellung **↓**.
Haube wieder aufsetzen!

Réglage des pressostats

Enlever les vis du capot en utilisant un tournevis N°3. ou PZ 2, Fig 1. Enlever le capot.

! **La protection n'est pas garantie, contact avec des pièces sous tension possible.**

Réglage des KS...A2-7

Régler le pressostat avec son bouton gradué **■** à la valeur désirée Fig.2.

Respecter les recommandations du constructeur du brûleur!

Le pressostat commute par pression montante: réglage **↑**. Le pressostat commute par pression descendante: réglage **↓**.
Remonter le capot!

Setting the pressure switch

Dismount the hood using a suitable tool, e.g. screwdriver no. 3 or PZ2, Fig. 1. Remove hood.

! **There is no protection against accidental contact. Contact with live parts is possible.**

Setting KS...A2-7

Set the pressure switch at the setting wheel **■** to the specified pressure setpoint using the scale, Fig. 2.

Follow the instructions of the burner manufacturer!

Pressure switch switches as pressure increases: Setting **↑**.
Pressure switch switches as pressure reduces: Setting **↓**.
Remount hood!

Regolazione del pressostato

Smontare la calotta con un attrezzo adeguato, ossia cacciavite nr. 3 - rispettiv, PZ 2, figura 1
Togliere la calotta.

! **Non é sostanzialmente garantita la protezione da scariche, é possibile il contatto con conduttori di tensione.**

Regolazione KS...A2-7

Tarare il pressostato, come in figura 2, sul valore di pressione nominale prescritto, agendo sulla rotella della scala graduata **■**.

Prestare attenzione alle prescrizioni del produttore del bruciatore!

Il pressostato scatta con pressione in salita: regolazione **↑**. Il pressostato scatta con pressione in discesa: regolazione **↓**.
Rimontare la calotta!

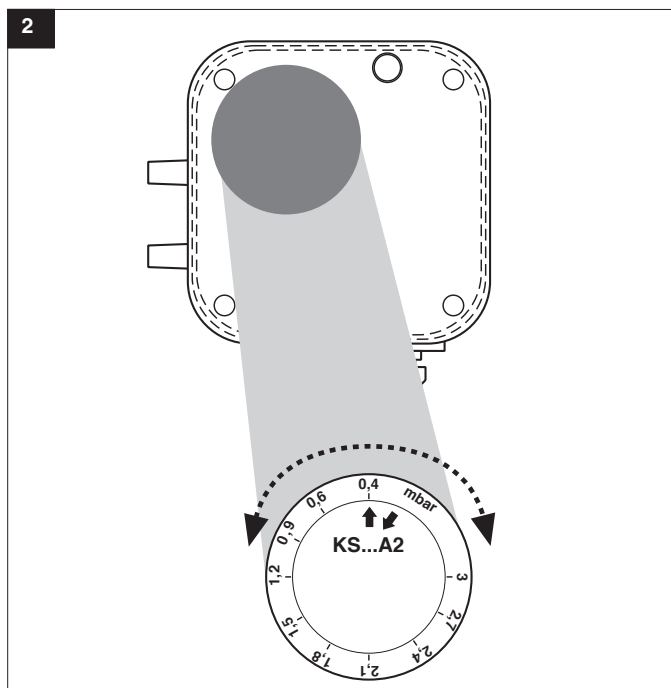
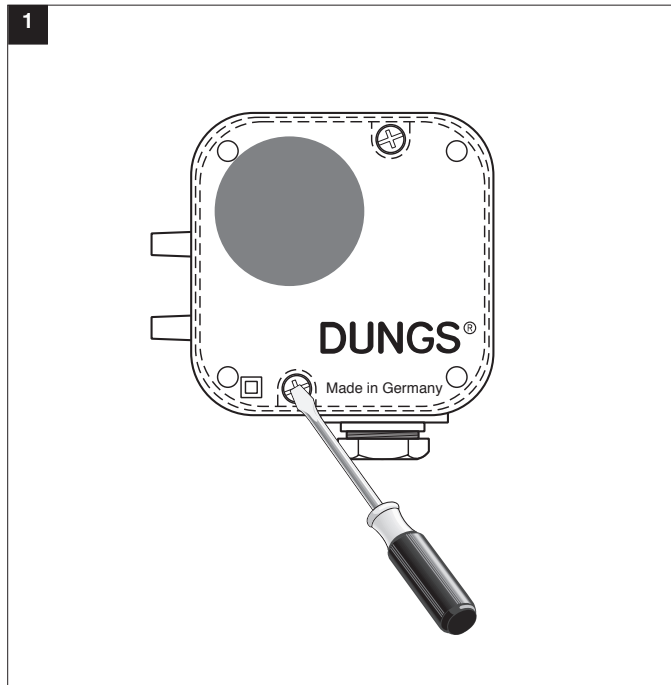

D

GB

F

I



Arbeiten am Druckwächter dürfen nur von Fachpersonal durchgeführt werden.

Work on the pressure switch may only be performed by specialist staff.

Seul du personnel spécialisé peut effectuer des travaux sur le pressostat.

Qualsiasi operazione effettuata sul pressostato deve essere fatta da parte di personale competente.



Kondensat darf nicht in das Gerät gelangen. Bei Minustemperaturen, durch Vereisung Fehlfunktion/Ausfall möglich.

Do not allow condensate to flow into the equipment. In case of sub-zero temperatures, malfunction or equipment failure may be possible due to icing.

Eviter l'entrée de condensats dans le pressostat, une prise en glace par température négative nuirait à son fonctionnement.

Nell'apparecchio non deve infiltrarsi alcuna condensa. Alle temperature negative sarebbero possibili disfunzioni dovute a formazione di ghiaccio.



Nach Abschluß von Arbeiten am Druckwächter: Dichtheitskontrolle und Funktionskontrolle durchführen.

On completion of work on the pressure switch, perform a leakage and function test.

Une fois les travaux sur le pressostat terminés, procéder toujours à un contrôle d'étanchéité et de fonctionnement.

Al termine dei lavori effettuati su un pressostato: predisporre un controllo sia della tenuta che del funzionamento.



Niemals Arbeiten durchführen, wenn Spannung anliegt. Offenes Feuer vermeiden. Örtliche Vorschriften beachten.

Never perform work if power is applied. No naked flame. Observe local regulations.

Ne jamais effectuer des travaux sous tension. Eviter toute flamme ouverte. Observer les réglementations.

In nessun caso si debbono effettuare lavori in presenza di tensione elettrica. Evitare i fuochi aperti e osservare le prescrizioni pubbliche.



Bei Nichtbeachtung der Hinweise sind Personen- oder Sachfolgeschäden denkbar.

If these instructions are not heeded, the result may be personal injury or damage to property.

En cas de non-respect de ces instructions, des dommages corporels ou matériels sont possible.

La non osservanza di quanto suddetto può implicare danni a persone o cose.



Silikonöle und flüchtige Silikonbestandteile (Siloxane) in der Umgebung vermeiden. Fehlfunktion / Ausfall möglich.

Avoid silicone oils and volatile silicones (siloxanes) in the environment. Malfunction/failure possible.

Eviter les huiles de silicone et les éléments de silicone volatils (siloxanes) dans l'environnement. Dysfonctionnement / panne possibles. Malfunction/failure possible.

Evitare oli silconici e componenti silconici volatili (silossani) nell'ambiente. Possibile disfunzione / guasto.



Alle Einstellungen und Einstellwerte nur in Übereinstimmung mit der Betriebsanleitung des Kessel-/Brennerherstellers ausführen.

Any adjustment and application-specific adjustment values must be made in accordance with the appliance-/boiler manufacturers instructions.

Effectuer tous les réglages et réaliser les valeurs de réglage uniquement selon le mode d'emploi du fabricant de chaudières et de brûleurs.

Realizzare tutte le impostazioni e i valori impostati solo in conformità alle istruzioni per l'uso del costruttore della caldaia/del bruciatore.

